



Product Description

The Automatic Transfer Switch Option may be added to any FD type Fire Pump Controller whenever automatic transfer from normal to alternate power is required.

The automatic Transfer Switch and Fire Pump Controller are mounted in the same enclosure or in separate enclosures to form one unit and interwired - depending on the horsepower and voltage required.

Engine Test Button

An engine test button is provided on the ATC-300 controller that can be used to test the Source 2 (generator) engine. The operator can select the engine run test time (0-600 minutes). As well, a silence pushbutton is provided which de-energizes the alarm bell.

Electrically and Mechanically Interlocked

The FT Series transfer switch operating mechanisms are mechanically interlocked to prevent the normal and alternate source from connecting at the same time. The switch operates upon signals received from the ATC-300 Plus controller.

ATC-300 Plus

The panel mounted, multi-function, microprocessor based ATC-300 Plus controller accurately monitors two power sources and provides the necessary intelligence to reliably operate the transfer switch through a series of programmed sensing and timing functions.



Keypad Programming

The ATC-300 Plus controller membrane is equipped with seven keypad input buttons which are used to program the controller as well as set operating parameters.

LED Status Indication

Five LED's indicate the status of the power sources.

Source 1 Available	Source 1 Connected
Source 2 Available	Source 2 Connected
Unit Status	

Automatic Transfer

The FT Series Transfer Switches will perform an automatic transfer from Normal to Alternate source when the Voltage drops to 85% of normal, or there is a loss of any phase and/or Phase Reversal.



Voltage and Frequency Sensing

The ATC-300 Plus continuously monitors the normal source for out of range setpoint values. When the source is outside the dropout setpoints, the source will become unavailable. This prompts a transfer to the alternate source. Retransfer occurs when the normal source's frequency and/or voltage return within pickup setpoints.

Alarm Relay

The alarm relay is de-energized to indicate an absence of an alarm state and energized to indicate the presence of an alarm condition. Alarm conditions include:

- Improper Circuit Breaker Operation
- Motor Operator Failure
- Lockout
- Failsafe Condition
- Aborted Engine Test
- Aborted Plant Exerciser
- Unsuccessful in-phase Transition

Product Features

The FT70 Transfer Switch Controllers use a method of connecting the pump motor windings into wye configuration to start, then switching to a delta configuration to run.

This reduces the starting current of the motor significantly.

Wye-Delta starting is the only method that has a starting torque efficiency of 100%. The FT70 can be programmed for either fully automatic or semi-automatic operations.

Logic Controller Board

Communication

The controller can be ordered with the option to display and output current values and status, on command, from various software protocols through the appropriate port(s).

Embedded Web Page

The web page is a multifunction tool that allows the user to view the controller's current status, data values, programmed set points and history. It is accessed using the optional ethernet port.

USB Port / USB Drive

The logic controller board is equipped with a USB port that can be used to transfer data to and from a portable USB Drive device (memory stick).



Ethernet Port

An optional ethernet port is used for direct connection to a computer for data transfer.

RS485 Serial Port

An optional RS485 serial port can be provided for communication to various external software programs.

Buzzer

A buzzer is mounted on the logic board which will operate if Fail to Start, Hardware Malfunction or any Common Alarm condition exists.

Power I/O Board

Transformers

Incoming line voltage is run directly to the I/O board from the incoming lines. The three transformers mounted on the I/O board will accept voltage inputs between 100 and 600V.

Customer Connection Terminals

Connection terminals for external customer connections, are located on the top of the Power I/O board.

Output Relays

Seven socket mount, 8 Amp, 2 Form - C (DPDT) output relays are provided standard on each power I/O board. They are designated for:

- Common Alarm,
- Phase Failure,
- Phase Reversal,
- Pump Run,
- Startup,
- Acceleration
- and Future # 1.

Each socket has an LED mounted on the I/O board which indicates each relay's coil status.



Optional Output Relay Boards

There is provision to add up to eight additional relay outputs, via optional relay output boards. Each board contains a maximum of 2 additional relays. The Power I/O Board will accept a maximum of 4 optional boards which mount in a snap-on configuration.

Each board provides an area for the user to label the terminal number and relay name.

Door Mount

The membrane keypad is accessible from the front door of the controller.

NEMA Rating

The standard membrane keypad is rated for NEMA 2, 3R, 4, 4X and 12.

LCD Display

The Logic Control Board contains a 4 Line by 40 Characters wide, backlit, LCD display which is capable of generating multiple languages.

Alarm & Status LED's

A total of 20, (10 Status - 10 Alarm) LED's provide indication on the membrane keypad.



Status LED's

Power On
Pump Running
Local Start
Remote Start
Deluge Valve
Emergency Start
Interlock On
Low Pressure
Auto Shutdown Enabled
Programmable LED # 1

Alarm LED's

Phase Reversal
Phase Failure
Fail To Start
Undervoltage
Overvoltage
Low Room Temperature
Locked Rotor Trip
Low Suction Pressure
Source 2 Disconnected
Programmable LED # 2

Silence Button

A silence pushbutton on the membrane can be used to silence the buzzer. When an alarm condition exists, the alarm buzzer will sound. If the Silence Alarm button is pressed, the alarm buzzer will turn off. If a subsequent alarm condition occurs after the silence button is pressed, the buzzer will re-sound. Pressing the Silence Alarm button again, will silence the buzzer.

Motor Test Button

The motor test button on the membrane can be used to simulate an automatic start.

Automatic Shutdown Enabled

When the Automatic Shutdown function is enabled, a Green LED will indicate on the controller membrane.

MAIN DISPLAY

General

The main display will show the current system pressure, time and date, voltage and amps reading for all three phases, the system frequency and any custom messages, alarms or timers.



Programmed Set-Point

The set-point display will show programmed pressure start point, pressure stop point and weekly test timer setting.

Statistics

The statistics display will allow the user to scroll through all of the measured statistics stored in memory. Refer to LMR Plus operation manual IM05805020K for specific details.

Diagnostics

The diagnostics display will allow the user to scroll through eleven diagnostic points to assist with troubleshooting the system.

Message History

The user will be able to scroll through all of the messages stored in the memory of the controller with the most recent message being displayed first.

PRINT Menu Description

All fault and alarm information is sent to the USB and Printer ports on demand, as well as the status of each output. The LMR Plus will store up to 10K events which are time and date stamped. All information can also be retrieved and displayed on the LCD display.

Saving to USB Drive

The controller will save four separate text files, one CSV file and the embedded webpage to the USB external drive. The files, at maximum size, can be saved multiple times on one 128MB USB drive.

Files to be saved are: Status Report, Diagnostics Report, Statistics Report, Configuration File and Last 10K Messages.

Print Menu

The printer menu is accessed in order to select the desired print function. Functions include: Print Messages, Last XX Messages, Date & Time, Status Report, Diagnostics Report and Statistics Report.

Custom Messages

When this item is selected, custom messages can be cleared from memory or downloaded from the USB external drive.

Firmware Update

Firmware revisions are updated from an external USB drive. All previously programmed settings will remain intact when updating is completed. Should there be an update failure, the controller will automatically revert back to the previous version of firmware.

Embedded Webpage

General

The embedded webpage is a multifunction tool that will allow the user to view the current status of the controller as well as display all current readings, set points, and history. An external computer can be connected via the optional Ethernet port to access the page. When connected, the controller set points can be programmed via the webpage.



Multiple Pages

There are 5 viewable pages that show the Main Display, Statistics, Diagnostics, History and Programmed Set Points.

Pressure Points

The pressure reports recorded in memory can be graphed and/or sorted based on date and time.

Programmed Set Points

All of the programmed set points and their current status can be viewed via the webpage.

Custom Messages

Users can create custom messages on a computer and upload to the controller using a USB Drive (memory stick). Up to 10 custom messages of up to 100 characters each, will continuously scroll across the fourth line of the LCD display once uploaded.



Trigger Points

The message can be programmed to appear at specific trigger points such as specific date and time, specific number of operations, specific number of hours run or at any individual alarm point.

All of the trigger points can be selected as And/ Or values.

Product Features

Programming Menu

General

The LMR Plus programming menu is divided into 8 different sub-menus. Each sub-menu contains information relative to its particular function. A brief description of each sub-menu is listed below.

Language

The language sub-menu allows the user to select English, French or Spanish or Other languages to be viewed on the LCD Display. Several other languages can be uploaded into the controller. Contact the factory for details.

Regional

Regional settings include the ability to program the date by adjusting the Month, Day, Year and Day of Week. As well, the Current Time can be adjusted on the 24 hour clock.

Pressure

A variety of pressure settings can be programmed in the pressure sub-menu. These settings include disabling the pressure transducer; setting of the start point, stop point, low pressure alarm, high pressure alarm, stop mode, proof pressure switch (for foam units), low suction shutdown (low foam shutdown), pressure deviation and hourly pressure recording. Refer to the LMR Plus operation manual IM05805020K for details.

Timers

Timers in the LMR Plus that can be programmed include: Run Period Timer (RPT), RPT Start Mode, Acceleration Timer (AT), Weekly Test Timer, Fail to Start Timer (FST) and Sequential Start Timer (SST). Refer to the LMR Plus operation manual IM05805020K for details.

Alarm Set Points

There are five settable alarm points that can be programmed by the user. They include: Phase Rotation, Over Voltage (OV), Under Voltage (UV), Over Frequency (OF) and Under Frequency (UF). Refer to the LMR Plus operation manual IM05805020K for details.

Custom Inputs / Outputs

There is provision on the Power I/O Board to accept up to 9 additional inputs and 9 additional outputs. The inputs can be labeled using one of 11 pre-set input descriptions or assigned a custom description that is programmed by the user. The optional outputs can be programmed to indicate up to 25 output conditions. As well, two optional alarm LED's can be programmed for up to 12 alarm conditions. All optional inputs, outputs and LED's can be linked, as required.

Inputs can be programmed to energize the common alarm output, link to relays and optional LED's and latch until reset by the user. Outputs can be programmed for fail safe and latch until reset by the user. Optional inputs and outputs can be programmed with time delay functions.

USB External Drive

General

When using an external USB Drive, the drive should conform to the following minimum specifications:



Min: 128mb
Max: 2 Gig
FAT16 protocol
USB 1.0 or 2.0

Drain Valve Solenoid

All LMR Plus electric controllers are equipped with a drain valve solenoid used for weekly test purposes.



NEMA 2 Enclosures

All LMR Plus controllers come standard with NEMA 2 enclosures unless otherwise ordered. Available options include: NEMA 3R, 4, 4X, 12.

Emergency Start Operator

A mechanically operated emergency start handle activates the motor contactor independent of any electrical control circuits or pressure switch input.



Standards & Certification

The LMR Plus Electric Fire Pump Controllers meet or exceed the requirements of Underwriters Laboratories, Underwriters Laboratories Canada, Factory Mutual, the Canadian Standards Association, New York City building code, CE mark and U.B.C / C.B.C. Seismic requirements, and are built to NFPA 20 standards.



Pump and Plumbing

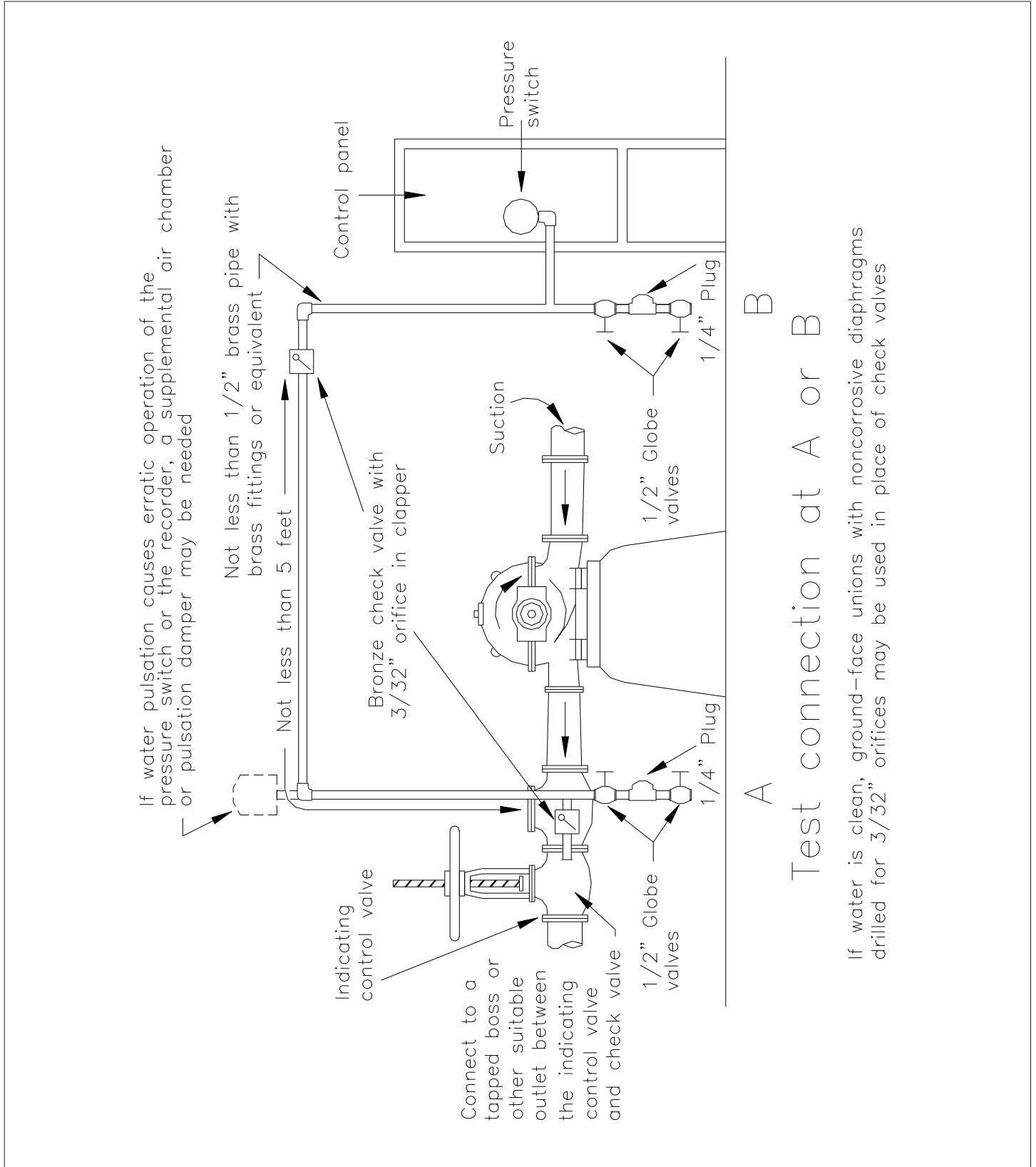

A **B**
Test connection at A or B

If water is clean, ground-face unions with noncorrosive diaphragms drilled for 3/32" orifices may be used in place of check valves

Main Display

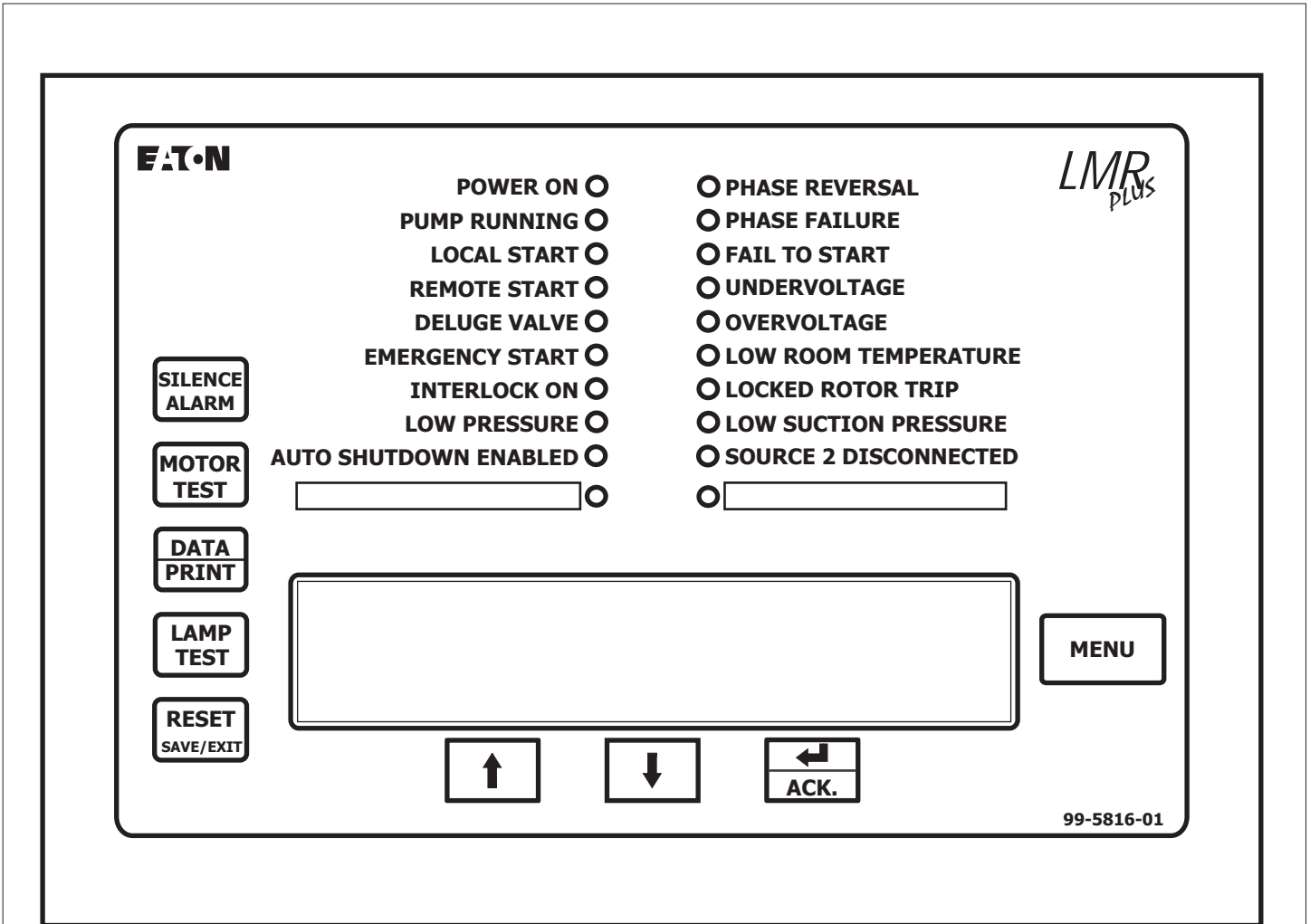

NOTES:

1. Refer to the LMR Plus technical manual for detail and setup information, as well as programming and custom labelling for Programmable LED # 1 and Programmable LED # 2.



N. Y. C.
APPROVED



NOTE: As of January 1, 2009 - All Limited Service Controllers will not carry FM Approval.

Main Display

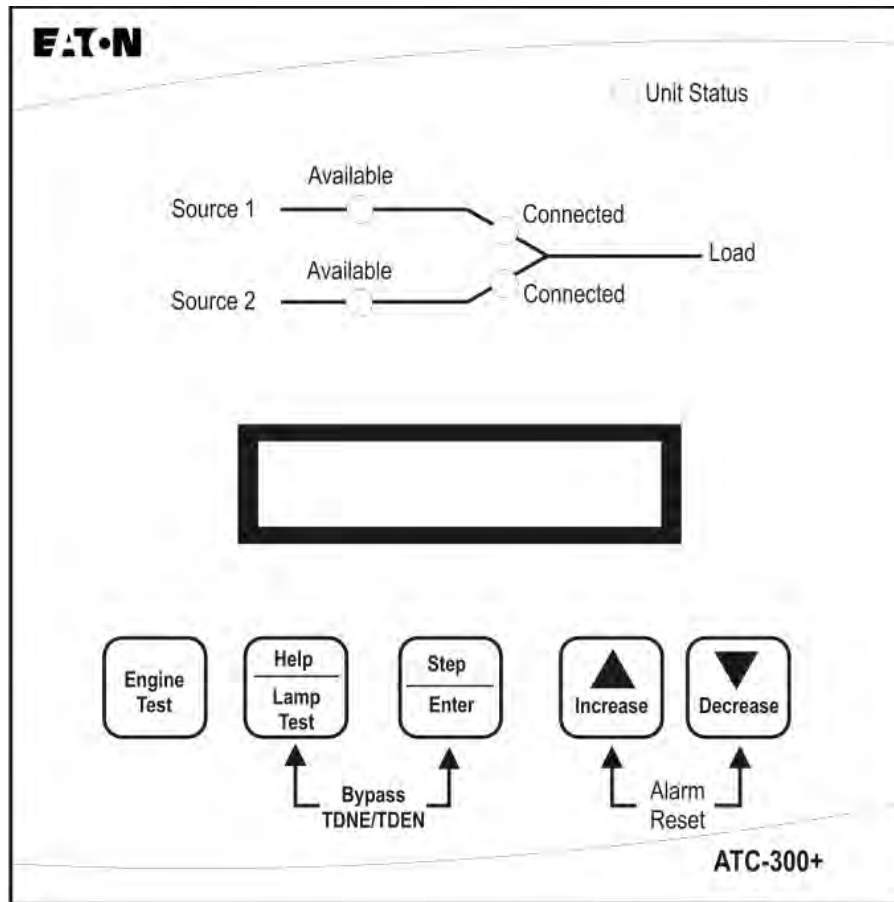

Note: For setup and programming information, refer to the Operation Manual for the EATON ATC-300 Plus Automatic Transfer Switch Controller - IM05805022K



Dimensions

Standard Enclosure - Type NEMA 2, 3R, 4, 4X, 12

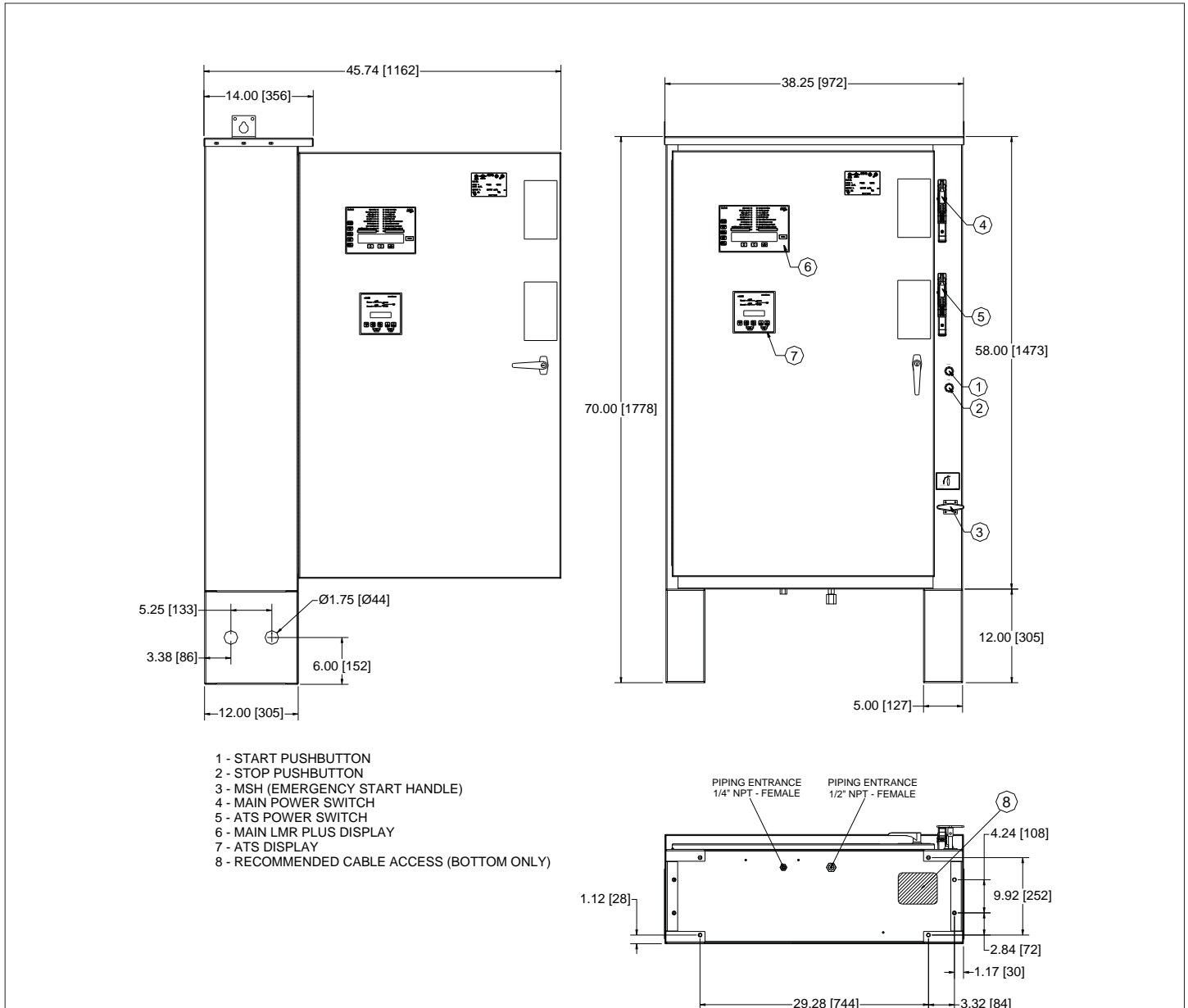

Dimensions in inches and [millimeters].

Motor Hp	Line Voltage	Withstand Rating			Approx. Weight Lbs. (Kg)
		Standard	Intermediate	High	
5 - 40	200 - 208V	100,000	150,000	200,000	425 (193)
5 - 50	220 - 240V				
5 - 75	* 380 - 415V				
5 - 100	440 - 480V				
5 - 100	550 - 600V	25,000	100,000		

* Coils Available: 380V-50Hz, 380V-60Hz, 415V-50Hz, 415V-60Hz

NOTES:

1. All enclosures finished in FirePump red.
2. Cable Entrance bottom only.
3. Standard Enclosure type NEMA 2.





Electrical Wiring Schematic

NOTES:
1. PHASE FAILURE AND COMMON ALARM RELAYS ARE ENERGIZED UNDER NORMAL OPERATING CONDITIONS.
2. TRANSFORMER ONLY REQUIRED ON UNITS 380V AND UP.
3. ALL RELAY CONTACTS ARE SHOWN IN NO POWER CONDITION.

LEGEND:
START CONTACTOR
1S - WYE POINT CONTACTOR
2M - RUN CONTACTOR
CB - CIRCUIT BREAKER
MIS - MANUAL START SWITCH
MWS - MANUAL START HANDLE (EMERGENCY)
TR1 - CONTROL TRANSFORMER

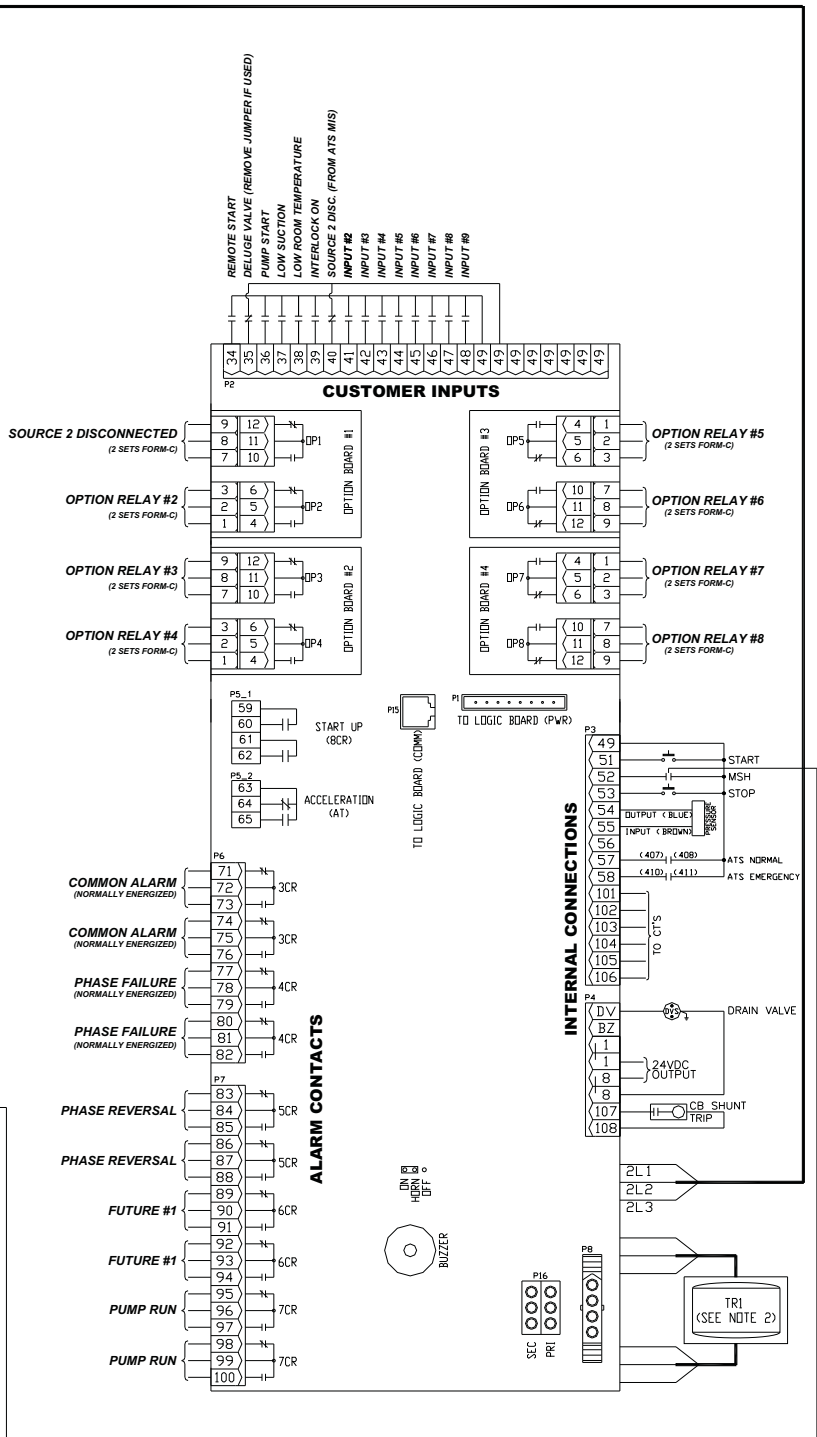
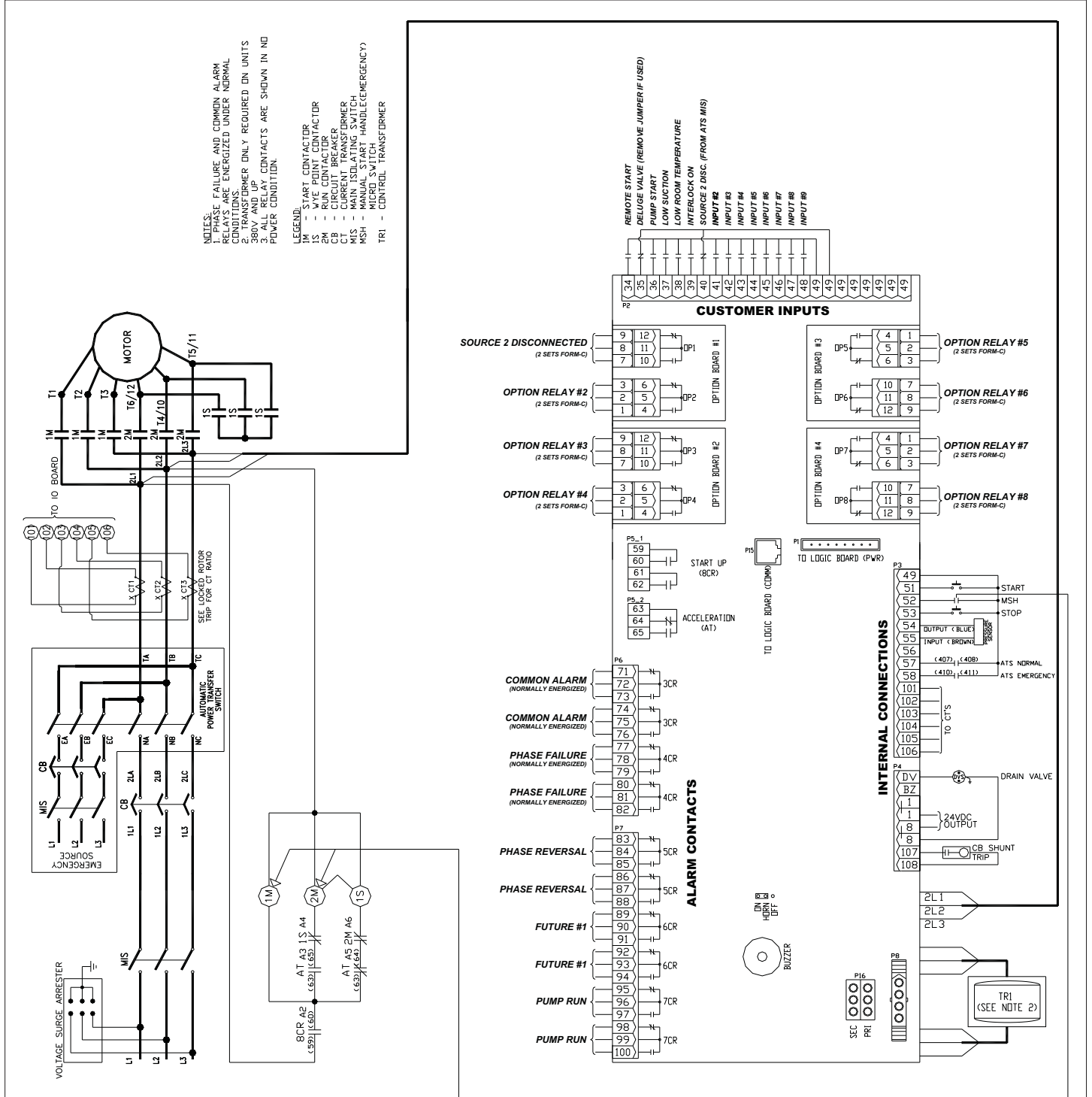

N. Y. C. APPROVED





Field Connections

Line Terminals (Incoming Cables)

	Line Terminals on Main Isolation Switch (Incoming Cables)					Qty. & Cable Sizes	Service Entrance GND. LUG Qty. & Cable Sizes
	LINE VOLTAGE						
	200 - 208	220 - 240	*380 - 415	440 - 480	550 - 600		
Max HP	25	30	40	60	75	(1)#14-1/0 PER Ø (CU/AL)	(1)#14-2/0 (CU/AL)
	40	50	75	100	100	(1)#4-4/0 PER Ø (CU)	(1)#4-350MCM (CU/AL)
	75	75	150	200	200	(1)#3-350MCM PER Ø (CU/AL)	(1)#4-350MCM (CU/AL)
	100	125	200	250	300	(2)3/0-250MCM PER Ø (CU/AL)	(2)1/0-750MCM (CU/AL)
	150	200	300	400	400	(2)250-350MCM PER Ø (CU/AL)	(2)1/0-750MCM (CU/AL)
	200	-	350	450	550	(2)#1-500MCM PER Ø (CU/AL)	(2)1/0-750MCM (CU/AL)
	250	300	500	600	700	(3)3/0-400MCM PER Ø (CU/AL)	(2)1/0-750MCM (CU/AL)

* Coils available: 380V-50Hz, 380V-60Hz, 415V-50Hz, 415V-60Hz.

Load Terminals (To Motor)

	Load Terminals (To Motor)					Qty. & Cable Sizes
	LINE VOLTAGE					
	200 - 208	220 - 240	380 - 415	440 - 480	550 - 600	
Max HP	20	25	30	40	40	(1)#14-#3 PER Ø (CU)
	40	50	75	100	100	(1)#14-1/0 PER Ø (CU/AL)
	60	75	100	150	150	(1)#6-250MCM PER Ø (CU/AL)
	150	150	250	300	300	(2)1/0-250MCM PER Ø (CU/AL)
	250	300	500	600	700	(2)2/0-500MCM PER Ø (CU/AL)

* For Proper Cable Size Refer to National Electrical Code NFPA-70

External Inputs

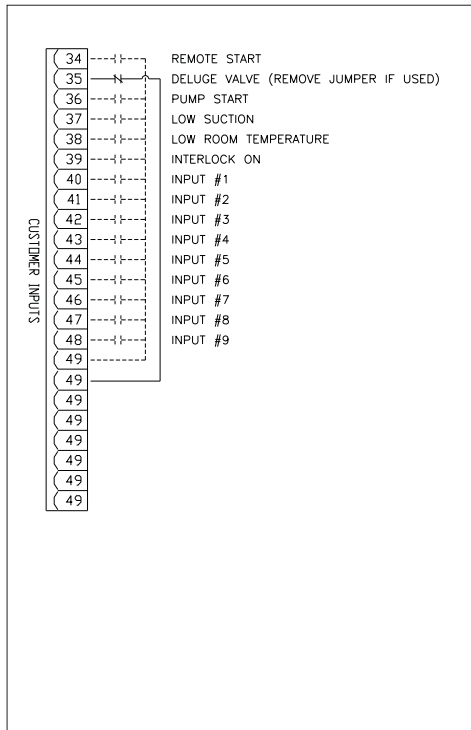

Alarm / Relay Outputs

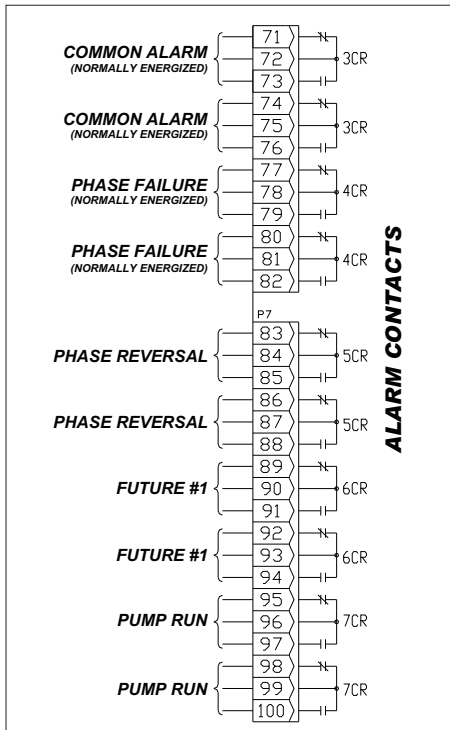

Typical Controller Connection

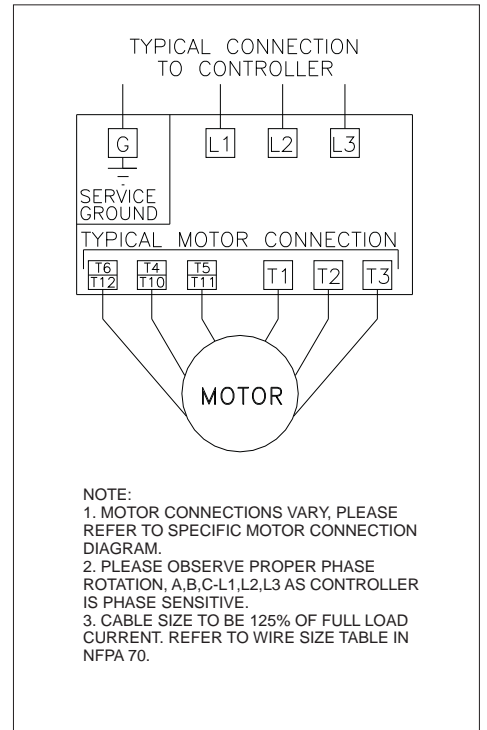

N. Y. C. APPROVED



Electrical Wiring Schematic

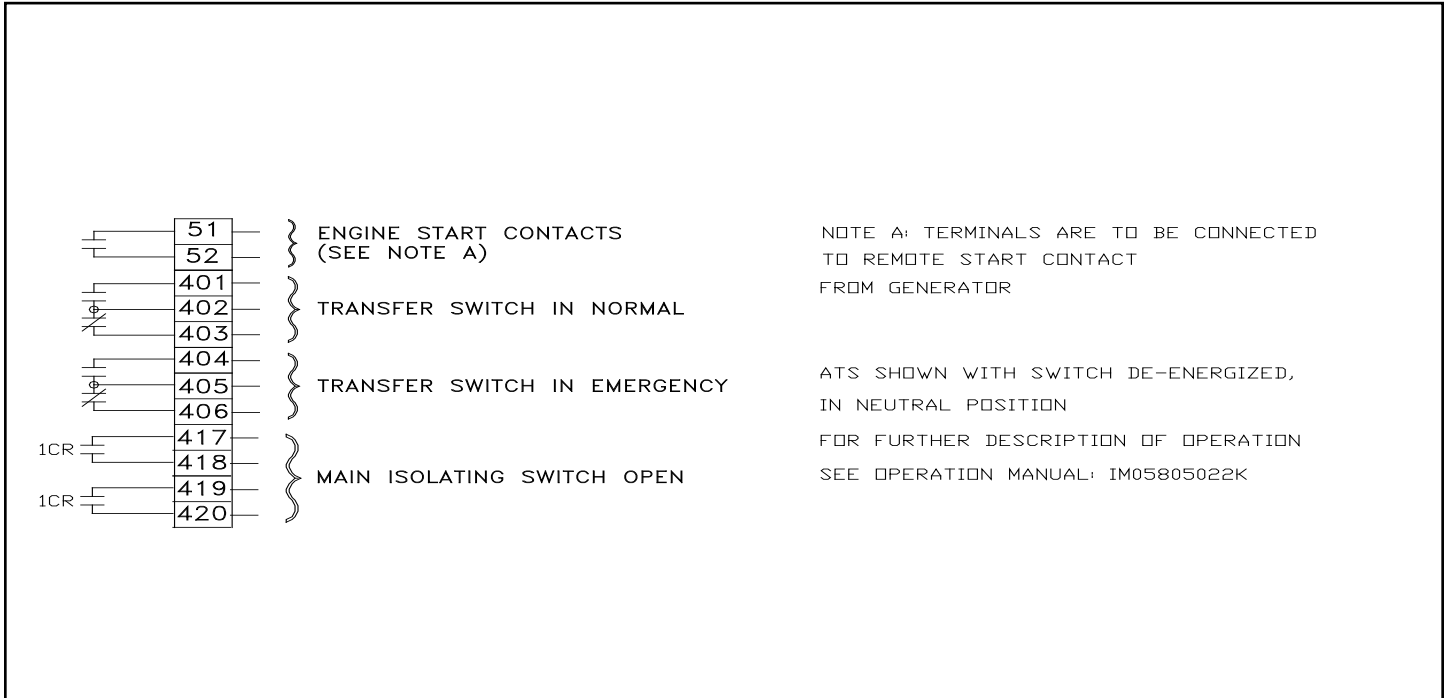

Technical Data and Specifications
Line Terminals (Incoming Cables)

	Line Terminals on Main Isolation Switch (Incoming Cables)						
	LINE VOLTAGE					Qty. & Cable Sizes	Service Entrance GND. LUG Qty. & Cable Sizes
	200 - 208	220 - 240	*380 - 415	440 - 480	550 - 600		
Max HP	25	30	40	60	75	(1)#14-1/0 PER Ø (CU/AL)	(1)#14-2/0 (CU/AL)
	40	50	75	100	100	(1)#4-4/0 PER Ø (CU)	(1)#4-350MCM (CU/AL)
	75	75	150	200	200	(1)#3-350MCM PER Ø (CU/AL)	(1)#4-350MCM (CU/AL)
	100	125	200	250	300	(2)3/0-250MCM PER Ø (CU/AL)	(2)1/0-750MCM (CU/AL)
	150	200	350	400	400	(2)250-350MCM PER Ø (CU/AL)	(2)1/0-750MCM (CU/AL)



March 2010



Electric Motor Connections

Wye-Delta Lower Nameplate Voltage

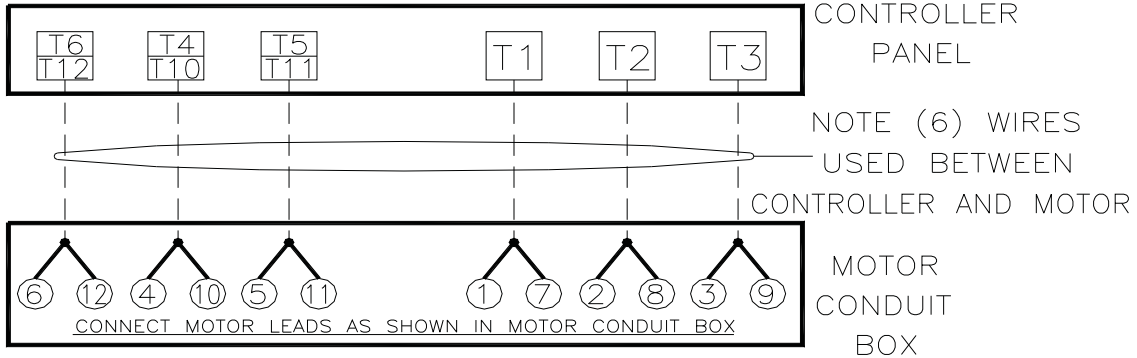

- NOTE:**
1. MOTOR CONNECTIONS VARY PLEASE REFER TO SPECIFIC MOTOR MANUFACTURER'S CONNECTION DIAGRAM.
 2. **FOR SINGLE VOLTAGE 12 LEAD MOTORS USE LOWER VOLTAGE CONNECTION DIAGRAM**

Wye-Delta Higher Nameplate Voltage

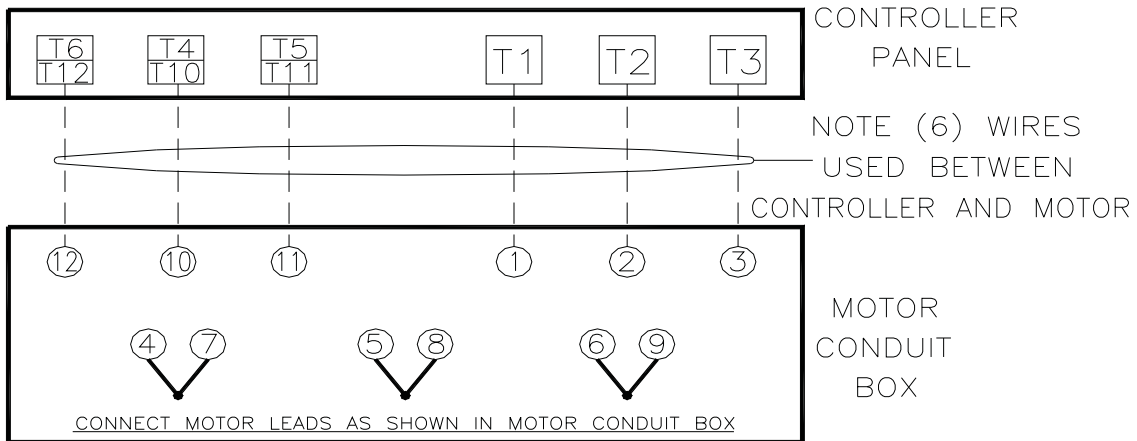

- NOTE:**
1. MOTOR CONNECTIONS VARY PLEASE REFER TO SPECIFIC MOTOR MANUFACTURER'S CONNECTION DIAGRAM.
 2. **FOR SINGLE VOLTAGE 12 LEAD MOTORS USE LOWER VOLTAGE CONNECTION DIAGRAM**



N. Y. C. APPROVED



Electrical Wiring Schematic

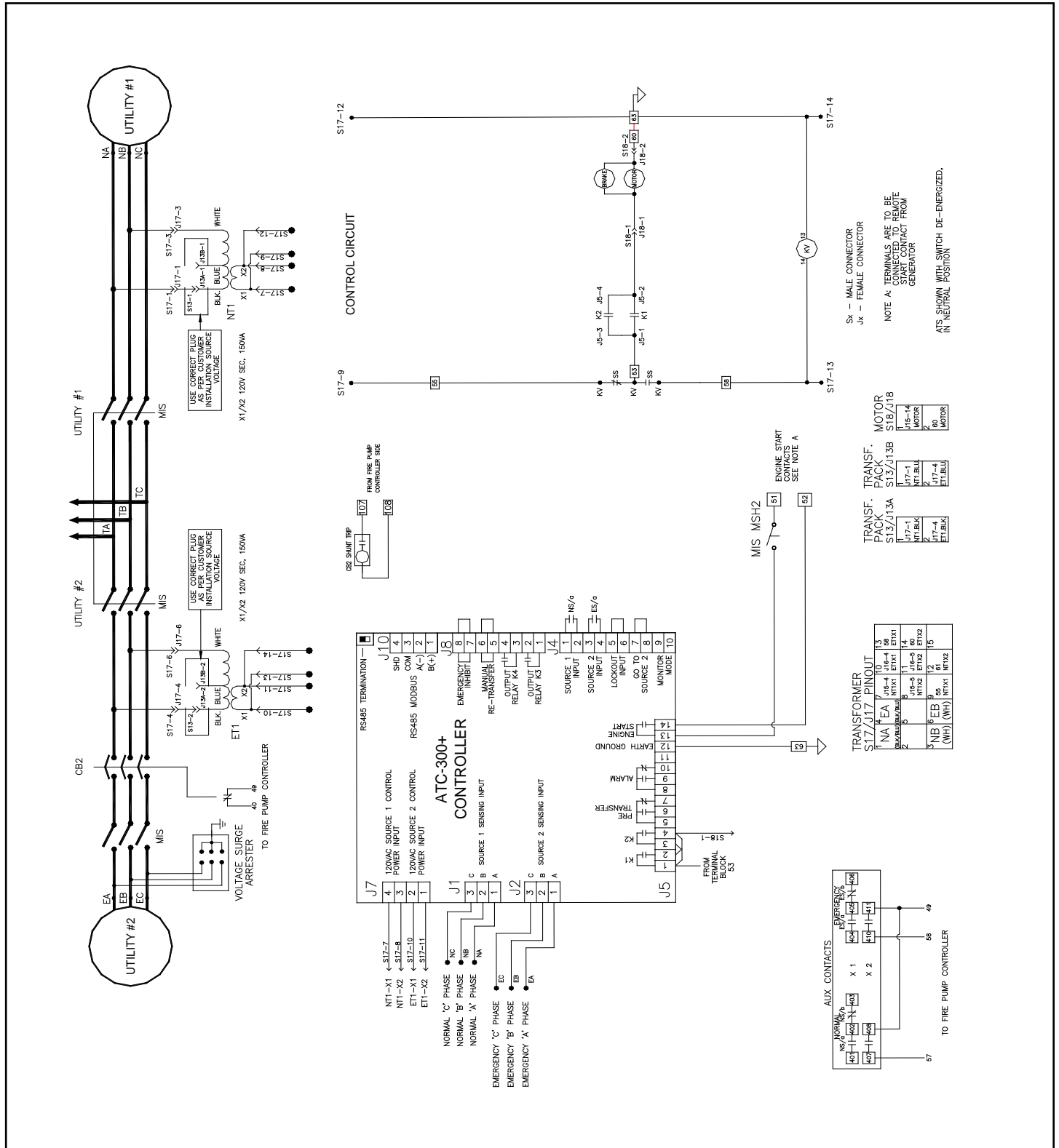

Part Number / Options Selection Guide

Electric Fire Pump Controllers & Transfer Switches



FD / FDF FT / FTF

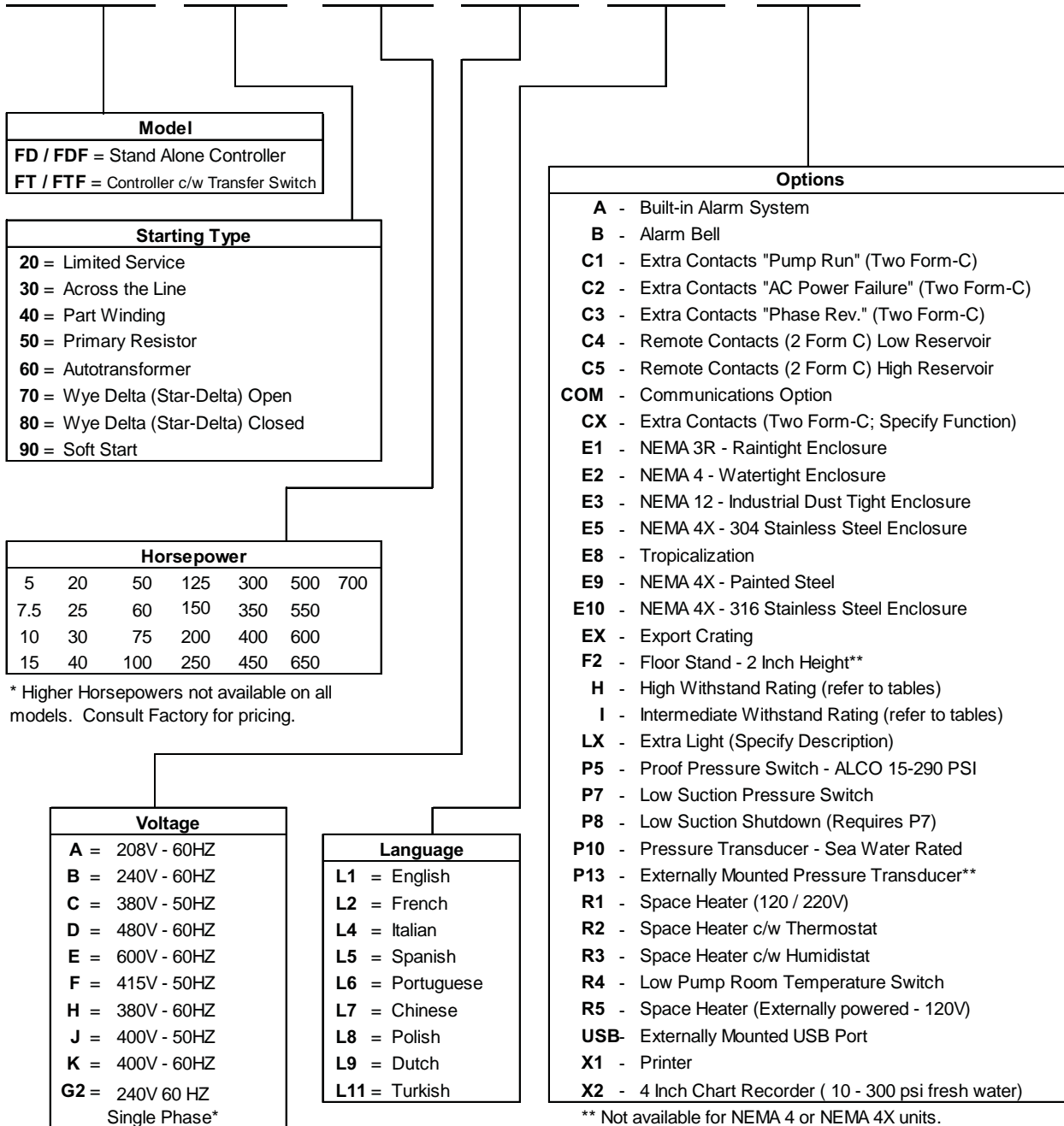

* Only available on Limited Service Controllers



Typical Specifications

1. Approvals

- A. The Fire Pump Controller and Transfer Switch combination shall meet the requirements of the latest edition of NFPA 20 and shall be listed by [Underwriters Laboratories (UL)] and approved by [Factory Mutual] (FM) **, [Canadian Standards Association (CSA)] and [New York Department of Buildings (NYSB)] for fire pump service.
- B. The transfer switch shall meet UL 1008 and shall be regularly subjected to Endurance, Interrupting Capacity, and Dielectric Voltage-Withstand test as outlined by UL 489 standards.

2. Ratings

- A. The transfer switch shall be suitable for the available short circuit current at the line terminals of the controller.
- B. The transfer switch shall have an ampere rating not less than 115% of the motor full-load current.

3. Construction

- A. The transfer switch shall be installed in a barriered compartment of the fire pump controller. The complete assembly, controller and transfer switch, shall be shipped as a single unit.
- B. A single uni-gear motor shall electrically operate the transfer mechanism. It shall also be capable of being operated manually and shall have suitable provisions for readily disengaging the gear motor when necessary.
- C. The transfer switch shall be mechanically and electrically interlocked so that it shall not be possible for the load circuits to be connected to normal and emergency sources simultaneously, regardless of whether the switch is electrically or mechanically operated. The switch shall have a manual neutral.
- D. The alternate side shall be provided with an isolation switch sized to a minimum of 115% of the motor full-load current and a circuit breaker having a continuous current rating not less than 115% of the motor full load amps. The isolation switch shall have overcurrent sensing elements of the non-thermal type, and instantaneous short-circuit overcurrent protection. (This does not apply to FPATS Stand Alone and FT20 Limited Service Transfer Switch Controllers.)
The isolating switch and circuit breaker shall be mechanically interlocked and operated by a single handle. (This does not apply to FT20 Limited Service Transfer Switch Controllers.)
The isolating switch shall be supervised to indicate when it is opened by audible and visual alarms.
- E. An auxiliary contact shall be provided to prevent sending of the signal for starting of the alternate source generator when the transfer switch commands it, if the isolation switch on the alternate source side of the transfer switch is open.
- F. The transfer switch shall be provided with locked rotor overcurrent protection. The locked rotor protector shall be calibrated and set to a minimum of 300% of the motor full-load current and have a tripping time between 8 and 20 seconds. (This does not apply to FT20 Limited Service Transfer Switch controllers.)

4. Enclosure

- A. The controller shall be housed in a NEMA Type 2 (IEC IP11) drip-proof, powder baked finish, freestanding enclosure.

5. Microprocessor Control

- A. A solid state sensing and control logic panel shall be separately mounted from the power-switching portion of the transfer switch. The two sections shall be connected together by control cables and plug-in connectors. The control section shall be capable of being isolated from the power section for maintenance.
- B. The normal power source shall be set to pickup at 95% and drop out at 85% of nominal supply. The voltage sensing on the alternate supply shall be set to pickup at 95% of nominal voltage.
- C. All voltage sensing, frequency sensing, and timer set points shall be field adjustable.
- D. The transfer switch shall automatically transfer its load circuit to an emergency or alternate power supply upon failure of the normal or original supply. In order to override momentary fluctuations in the system, a time delay transfer from normal to alternate power supply shall be adjustable up to 1800 seconds. Upon restoration of the normal supply, the transfer switch shall automatically retransfer its load circuits to the normal supply. Mechanically held transfer mechanisms shall be energized only momentarily during transfer or retransfer.
- E. If the emergency / standby power should fail while carrying the load, transfer to the normal supply shall be made instantaneously upon restoration of the normal source to satisfactory conditions.
- F. The transfer switch shall come complete with five LED's to provide visual indication of the unit status, source 1 available, source 1 connected, source 2 available, and source 2 connected.
- G. An engine test button shall be provided that will initiate an engine test.
- H. A silence alarm button shall be provided that will silence the alarm buzzer.

6. Alarm Relays

- A. 1 Form-C contact shall be provided for remote indication for source 1 connected or source 2 connected.
- B. 2 Form-C contacts shall be provided for remote indication for the alternate source-isolating switch open.

7. Manufacturer

- A. The manufacturer of the assembly shall be the manufacturer of major components and control modules installed within the assembly.
- B. The Transfer Switch Fire Pump Controller shall be of the LMR Plus type as manufactured by Eaton Industries (Canada) Company.
- C. Models:
FT20 Limited Service
FT30 Across the Line
FT40 Part Winding
FT50 Primary Resistor
FT60 Autotransformer
FT70 Wye-Delta (Star Delta) Open Transition
FT80 Wye-Delta (Star Delta) Closed Transition
FT90 Soft Start
FPATS Stand Alone Transfer Switch

** NOTE: FPATS Stand Alone and FT20 Limited Service Transfer Switch controllers, do not carry FM Approval.

LMR Plus Electric Fire Pump Controllers

Typical Specifications

1. Approvals

- A. The Fire Pump Controller shall meet the requirements of the latest edition of NFPA 20 and shall be listed by [Underwriters Laboratories (UL)] and approved by [Factory Mutual Research (FM)] [Canadian Standards Association (CSA)] [New York Department of Buildings (NYSB)] and carry the CE marking for fire pump service.

2. Starting Type

- A. The controller shall be of the combined manual and automatic type designed for [Full Voltage Starting] [Part Winding Starting] [Primary Resistor Starting] [Autotransformer Starting] [Wye-Delta (Star-Delta) Open Transition Starting] [Wye-Delta (Star-Delta) Closed Transition Starting] [Solid State Soft Start Starting]

3. Ratings

- A. The Controller shall have a withstand rating of 100,000 RMS symmetrical amperes @ [208V] [240V] [380V] [400V] [415V] [480V] [25,000 @ 600VAC].

4. Construction

- A. The controller shall include a motor rated combination isolating switch and circuit breaker, mechanically interlocked and operated with a single externally mounted handle.
- B. The isolating switch shall be rated to disconnect the motor load.
- C. The isolating switch/circuit breaker combination shall be mechanically interlocked such that the enclosure door cannot be opened when the handle is in the on position except by a tool operated defeater mechanism.
- D. The controller manufacturer shall manufacture the contactor, isolating switch, circuit breaker, pushbuttons, and enclosures. Brand-labeled components will not be accepted.

5. Enclosure

- A. The controller shall be housed in a NEMA Type 2 (IEC IP11) drip-proof, powder baked finish, freestanding enclosure.
- B. Optional Enclosures:
 - 1. NEMA 3R (IEC IP14) rain-tight enclosure.
 - 2. NEMA 4 (IEC IP66) watertight enclosure.
 - 3. NEMA 4X (IEC IP66) watertight 304 stainless steel enclosure.
 - 4. NEMA 4X (IEC IP66) watertight 316 stainless steel enclosure.
 - 5. NEMA 4X (IEC IP66) watertight corrosion resistant enclosure.
 - 6. NEMA 12 (IEC IP52) dust-tight enclosure.

6. Microprocessor Control

- A. The controller shall come complete with a 4 line by 40 character LCD display mounted on a panel opening in the front door. The LCD display shall indicate the following:
 - 1. Main screen displaying system pressure, three-phase voltage and amperage readings, system frequency, date, and time.
 - 2. Set point review screen displaying the programmed pressure start and stop points, and weekly test time.
 - 3. Controller statistics screen, including:
 - a. Powered Time
 - b. Motor Run Time
 - c. Number of Calls to Start
 - d. Number of Starts
 - e. Last Motor Start Time
 - f. Last Motor Run Time
 - g. Last Low Pressure Start
 - h. Minimum System Voltage
 - i. Maximum System Voltage
 - j. Minimum System Frequency
 - k. Maximum System Frequency
 - l. Minimum System Pressure
 - m. Maximum System Pressure
 - n. Last System Startup
 - o. Last Phase Failure
 - p. Last Phase Reversal
 - q. Last Locked Rotor Trip
 - r. Maximum Run Current
 - s. Last Locked Rotor Current
 - 4. Controller diagnostics screen, including:
 - a. Date & Time
 - b. Firmware Version
 - c. Shop Order Number
 - d. Customer Order Number
 - e. Transformer Output Voltage
 - f. Current Transformer Outputs
 - g. Pressure Transducer Calibrated Settings
 - h. Input Status
 - i. Output Status
 - 5. Display last messages screen that will display up to 10,000 alarms/messages stored in the controllers' memory.
 - 6. Display up to ten (10) custom messages of up to 100 characters each, which will continually scroll across the fourth line of the display.
 - 7. Remaining time left on active timers.
- B. The controller shall be supplied with ten (10) green status LED's for the following:
 - 1. Power On
 - 2. Pump Running
 - 3. Local Start
 - 4. Remote Start
 - 5. Deluge Valve
 - 6. Emergency Start

LMR Plus Electric Fire Pump Controllers

7. Interlock On
 8. Low Pressure
 9. Auto Shutdown Enabled
 10. Programmable LED #1
 - C. The controller shall be supplied with ten (10) red alarm LED's to indicate the following:
 1. Phase Reversal
 2. Phase Failure
 3. Fail to Start
 4. Undervoltage
 5. Overvoltage
 6. Low Room Temperature
 7. Locked Rotor Trip
 8. Low Suction Pressure
 9. Source 2 Disconnected
 10. Programmable LED #2
 - D. The microprocessor logic board shall be available with:
 1. A USB port for transference of message history, controller status, diagnostics, and statistics and the ability to update firmware.
 2. An optional Ethernet port for direct connection to a computer for data transfer.
 3. An optional RS485 Serial port for communication to various external software programs.
 - E. The controller shall be available with an embedded web page to allow viewing of the controllers' current status, data values, programmed set points, and history.
 - F. A Fail-to-Start alarm shall occur if the motor controller sees less than 20% of the motor full load amps after an adjustable time delay of 1-90 seconds.
 - G. Locked rotor protection shall be provided. After a trip condition and restoration of power, the LCD display shall indicate "LOCKED ROTOR TRIP".
 - H. A sequential start timer and weekly test timer shall be provided as standard.
 - I. A restart time delay of two (2) seconds shall be provided to allow the residual voltage of the motor to decay prior to re-starting the motor. In the event that the pump motor continues to run after a request to stop, then the controller must display a fail to stop message to indicate this condition.
 - J. Overvoltage (5-20%) and undervoltage (5-30%) sensing and alarming shall be provided as standard.
 - K. The controller shall be supplied with interlock and shutdown circuits as standard. A flashing green LED shall indicate an interlock on condition.
 - L. Where shutdown of the pump(s) due to low suction pressure is required, it shall be accomplished without the addition of a separate panel or enclosure. The LCD display shall indicate low suction shutdown. Resetting of the condition shall be automatic or manual as selected by the user.
 - M. Means shall be provided to test the operation of all LED's to ensure their functionality.
7. **Programming Menu**
 - A. The programming menu shall have the ability to enable an entry password.
 - B. The programming menu shall be limited to two (2) levels of password protection.
 - C. The controller shall have three (3) languages as a standard, English, French, and Spanish, with the ability to add a fourth language.
 - D. The programming menu shall be grouped into 6 main menu headings as follows:
 1. Regional Settings
 2. Pressure Settings
 3. Timer Values
 4. Alarm Set points
 5. Input/Output Menu
 6. System Configuration (password protected)
 8. **Pressure Sensor**
 - A. A solid-state 4-20mA pressure sensor shall be provided. The pressure Start and Stop points shall be adjustable in increments of one (1) PSI. A low pressure pre-alarm, indicated with a flashing green LED, shall denote a potential pump starting condition and will remain lit once the pump has started to indicate the starting cause.
 9. **Custom Inputs/Outputs**
 - A. The controller shall come standard with nine (9) future inputs, two (2) future LED indicators, and one (1) future output, with the ability to add up to another 8 outputs via optional relay boards.
 - B. The user shall be able to program the future inputs/outputs through the main programming menu.
 - C. The inputs shall be selectable based on the following criteria:
 1. User selected message or thirteen (13) predetermined messages.
 2. Energize the common alarm relay when the input is received.
 3. Link to a future relay and/or LED indicator.
 4. Alarm latched until reset.
 5. Normally open or closed input.
 6. On-delay timer.
 - D. The LED indicators shall be selectable based on the following criteria:
 1. Indication based on a minimum of twelve (12) predetermined alarms or a custom input.
 - E. The future relays shall be selectable based on the following criteria:
 1. Output based on a minimum of twenty-seven (27) predetermined alarms, controller status or a custom input.
 2. Latched until reset.
 3. Energized under normal conditions.
 4. On or off delay timer on the output.

LMR Plus Electric Fire Pump Controllers

10. Alarm Relays

- A. All relays shall be of the plug-in type. An LED on the relay panel shall indicate the energized state of the relay. All relay contacts shall be rated @ 8A, 277VAC/30VDC. Two (2) sets of Form-C contacts shall be provided for each of the following:
 - 1. Phase Reversal
 - 2. Phase Failure
 - 3. Common Alarm
 - 4. Future #1
 - 5. Pump Run.
- B. The Common Alarm and Phase Failure relays shall be energized under normal conditions.

11. Audible Alarm Buzzer

An audible alarm buzzer, capable of being heard while the motor is operating, shall operate if Fail to Start, Hardware Malfunction or any Common Alarm condition exists.

12. Manufacturer

- A. The controller shall be of the LMR Plus type as manufactured by Eaton Corporation.